

REV	DESCRIPTION	UP DATE	APPROVED
△			
△			

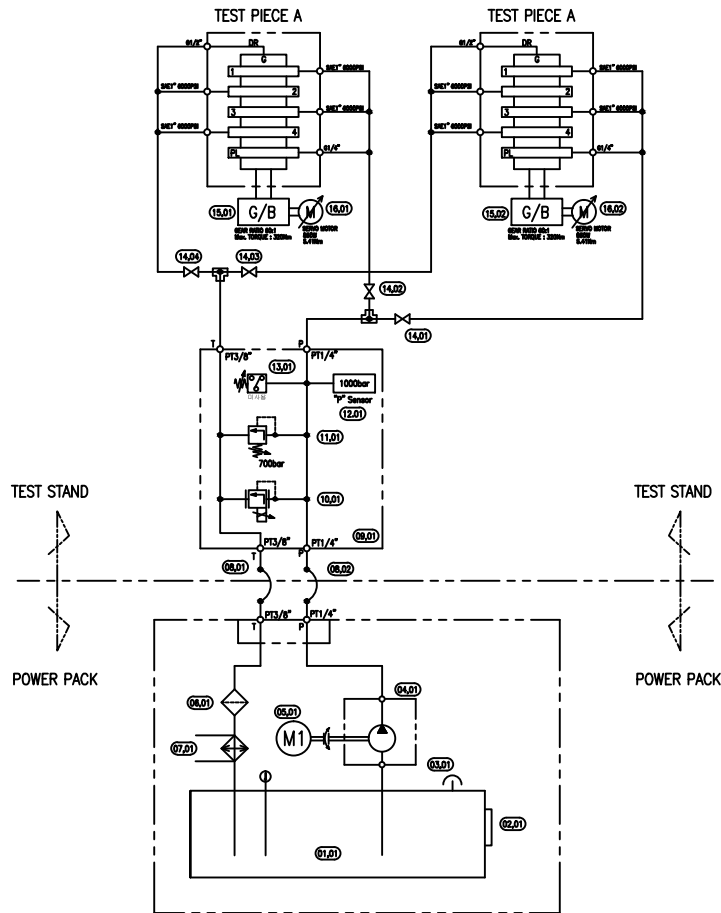

NO	TITLE	MODEL	MA'AL	QTY	REMARKS
NAME OR TITLE CENTER JOINT TESTER HYDRAULIC CIRCUIT					
DRAWING	DESIGN	CHECKED	APPROVED	VIEW	
CUSTOMER		DATA	SCALE	UNIT	DWG NO.
		18.08.25	1 : 1	mm	
REV					

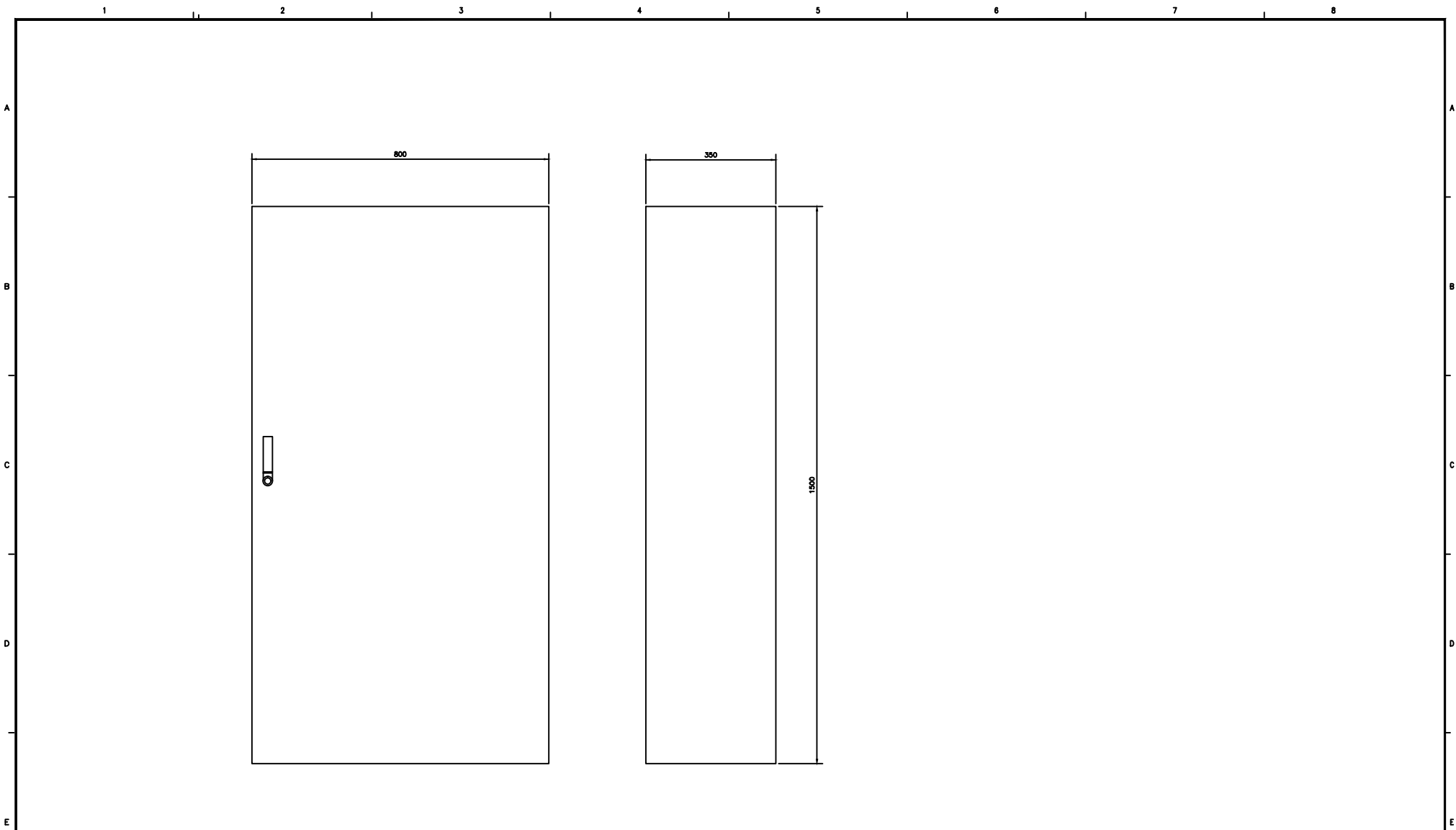

NO.	DATE	REVISIONS & DESCRIPTION	Drawn	Checked	Reviewed	Approved
▲	13.10.15					

NO.	DESCRIPTION	MAY (KG)	UNIT	TYPE	QUALITY	REMARKS	REMARKS
	건설기계 부품연구원						
TITLE	PLANT NAME	SCALE	N/A	PROJECTION	1st ANGLE	2nd ANGLE	3rd ANGLE
CENTER JOINT TESTER	ELECTRIC POWER PANEL	1:1	At	First Angle	Second Angle	Third Angle	
DATE	DATE	DATE	DATE	DATE	DATE	DATE	DATE

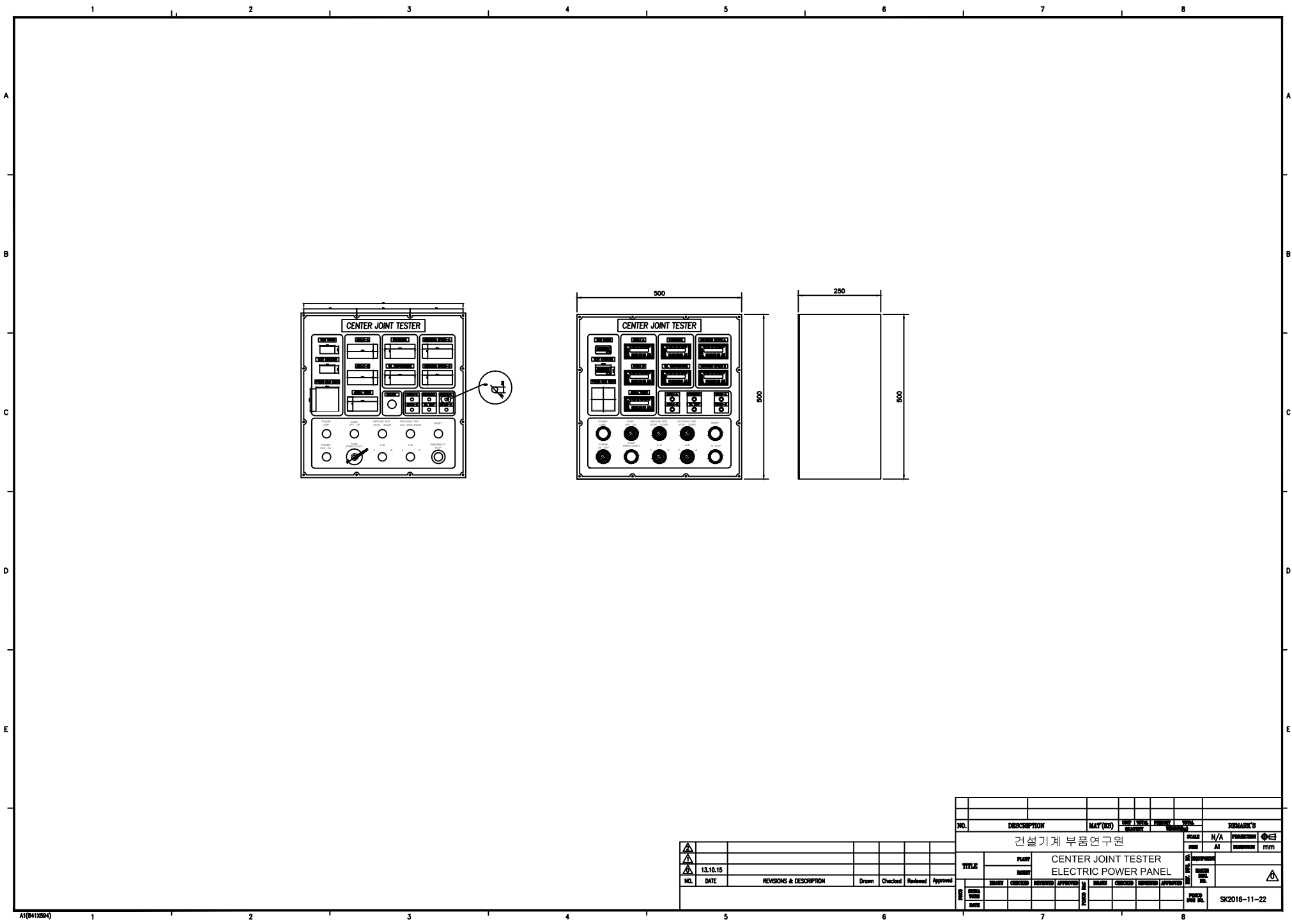

NO.		DESCRIPTION		MAY (KSI)		DATE		REVISIONS		REMARKS	
		건설기계 부품연구원		N/A		AT		N/A		N/A	
TITLE		CENTER JOINT TESTER ELECTRIC POWER PANEL		DRAWN		CHECKED		REVIEWED		APPROVED	
NO.		DATE		REVISIONS & DESCRIPTION		Drawn		Checked		Released	
DATE		13.10.15									

SOURCE  
3Ø 4W 380V

MCCB0  
ABS104/100A

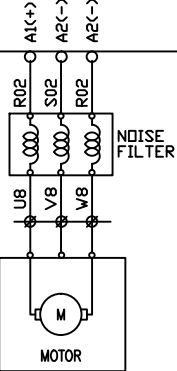
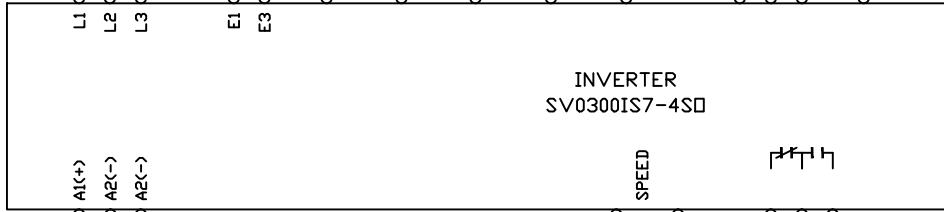
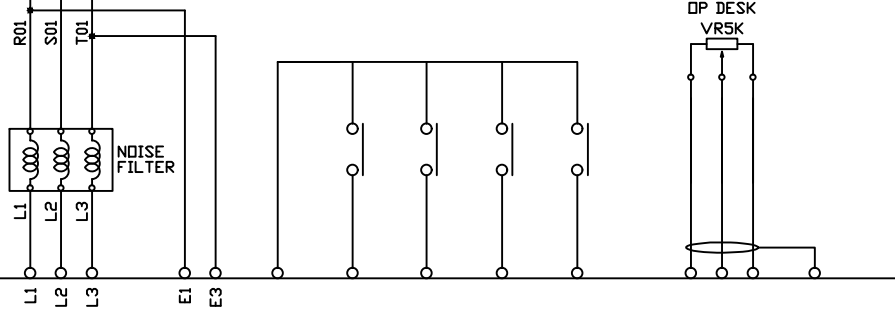
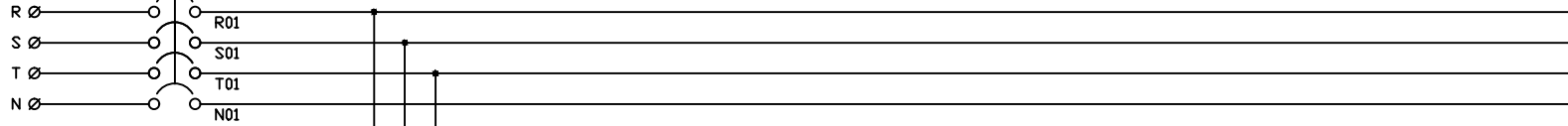

RT01 MOTOR  
22 KW

X060  
N24  
FAULT

NO.	DESCRIPTION	MAY (KW)	UNIT	TYPE	PLANT	TOTAL	REMARKS
	건설기계 부품연구원						
	CENTER JOINT TESTER ELECTRIC POWER PANEL						

NO.	DATE	REVISIONS & DESCRIPTION	Drawn	Checked	Reviewed	Approved
13.10.15						

TITLE	PLANT	NO.	DATE	NO.	DATE	NO.	DATE	NO.	DATE

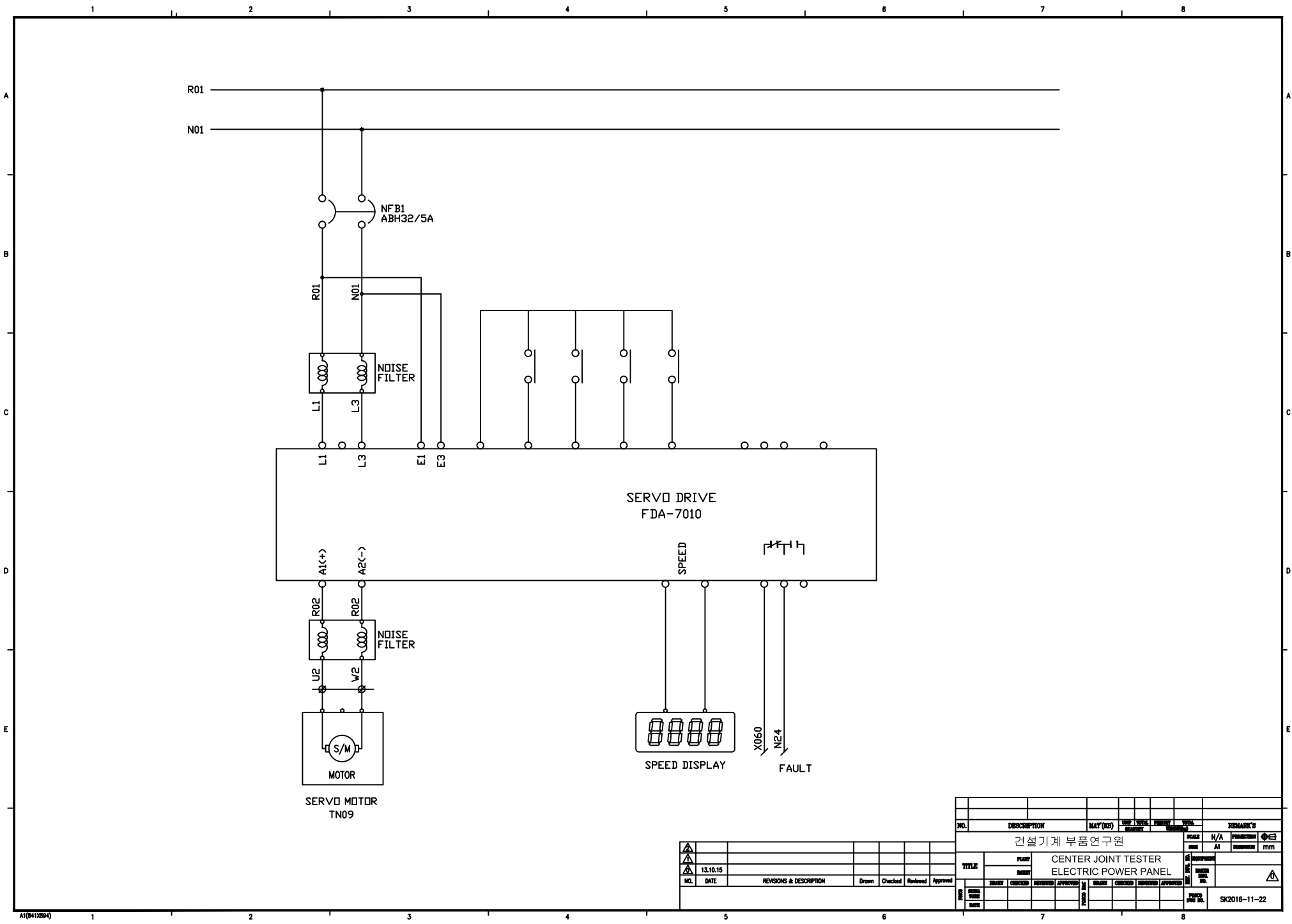

NO.	DATE	REVISIONS & DESCRIPTION	Drawn	Checked	Reviewed	Approved
1	13.10.15					

NO.	DESCRIPTION	MAY (KSI)	DATE	TYPE	REVISION	TOTAL	REMARKS
	건설기계 부품연구원						
	CENTER JOINT TESTER ELECTRIC POWER PANEL						

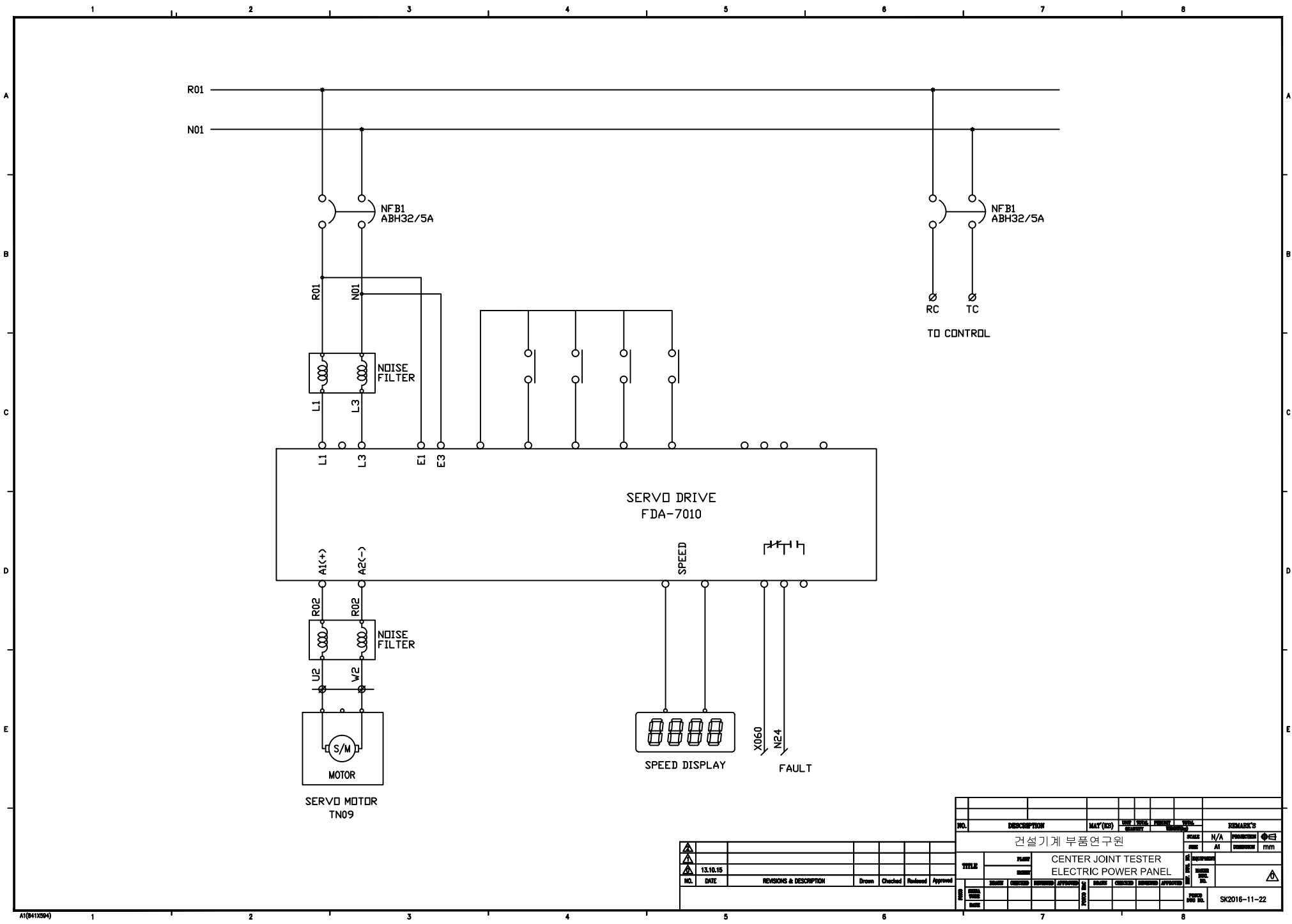

A1(0412504)

NO.	DATE	REVISIONS & DESCRIPTION	Drawn	Checked	Released	Approved
1	13.10.15					

NO.	DESCRIPTION	MAY (K2)	DATE	TYPE	REVISION	REMARKS
	건설기계 부품연구원					
	CENTER JOINT TESTER ELECTRIC POWER PANEL					

SK2016-11-22

1 2 3 4 5 6 7 8

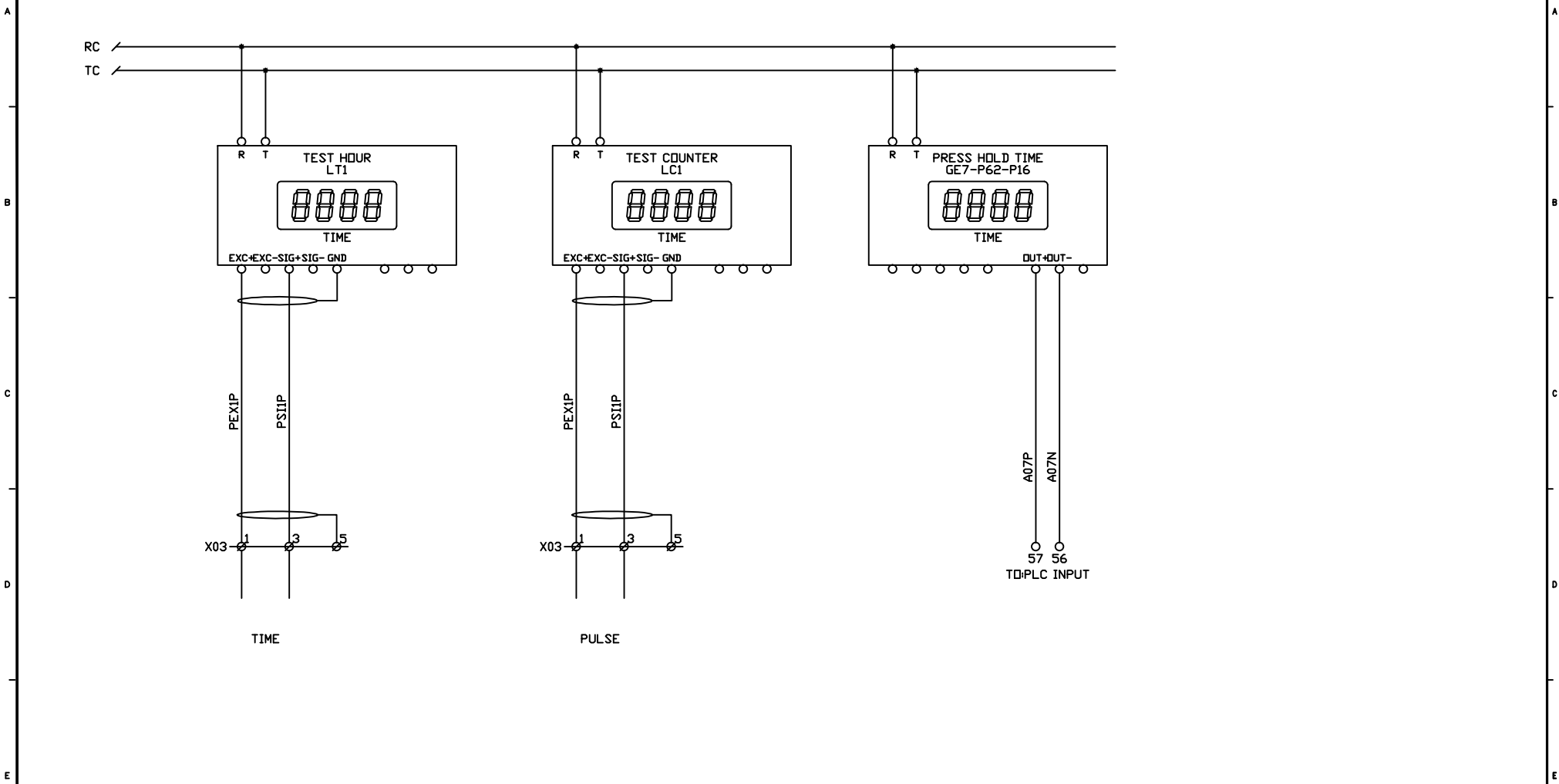

NO.		DESCRIPTION		MAY (K2)		DATE		REVISION		REMARKS	
		건설기계 부품연구원		N/A		AT		mm		mm	
TITLE		CENTER JOINT TESTER ELECTRIC POWER PANEL		DRAWN		CHECKED		REVIEWED		APPROVED	
NO.		DATE		REVISIONS & DESCRIPTION		Drawn		Checked		Released	
DATE											
PROJECT NO.		SK2016-11-22									

1 2 3 4 5 6 7 8

1 2 3 4 5 6 7 8

A  
B  
C  
D  
E

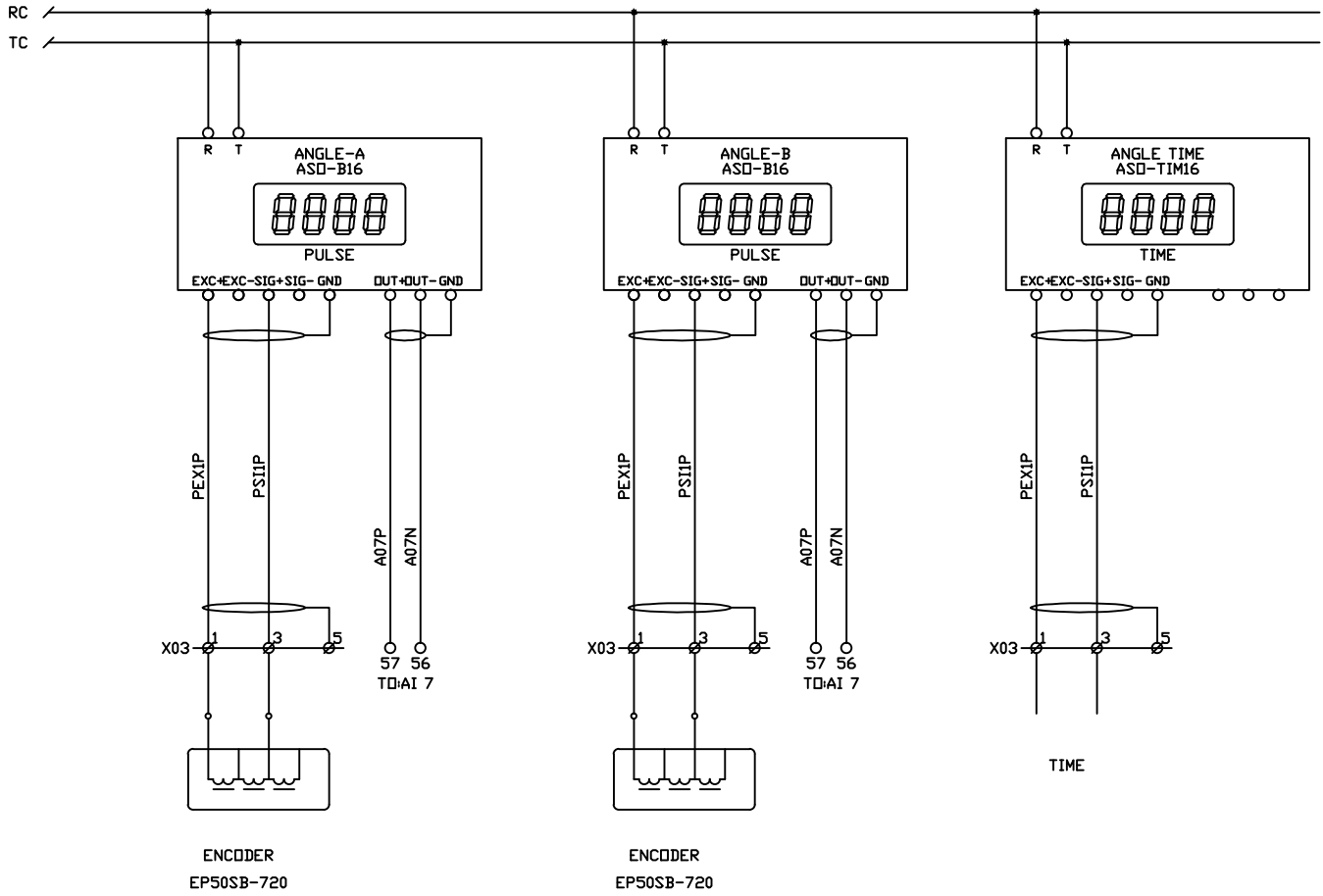

ENCODER  
EP50SB-720

ENCODER  
EP50SB-720

TIME

NO.		DESCRIPTION		MAY (K)		DATE		REVISION		REMARKS	
		건설기계 부품연구원								N/A	
		CENTER JOINT TESTER								N/A	
		ELECTRIC POWER PANEL								N/A	
NO.		DATE		REVISIONS & DESCRIPTION		Draw		Checked		Approved	
		13.10.15									
TITLE		PLANT		REVISION		APPROVED		DATE		NO.	
DATE		NO.		NO.		NO.		NO.		NO.	
										SK2016-11-22	



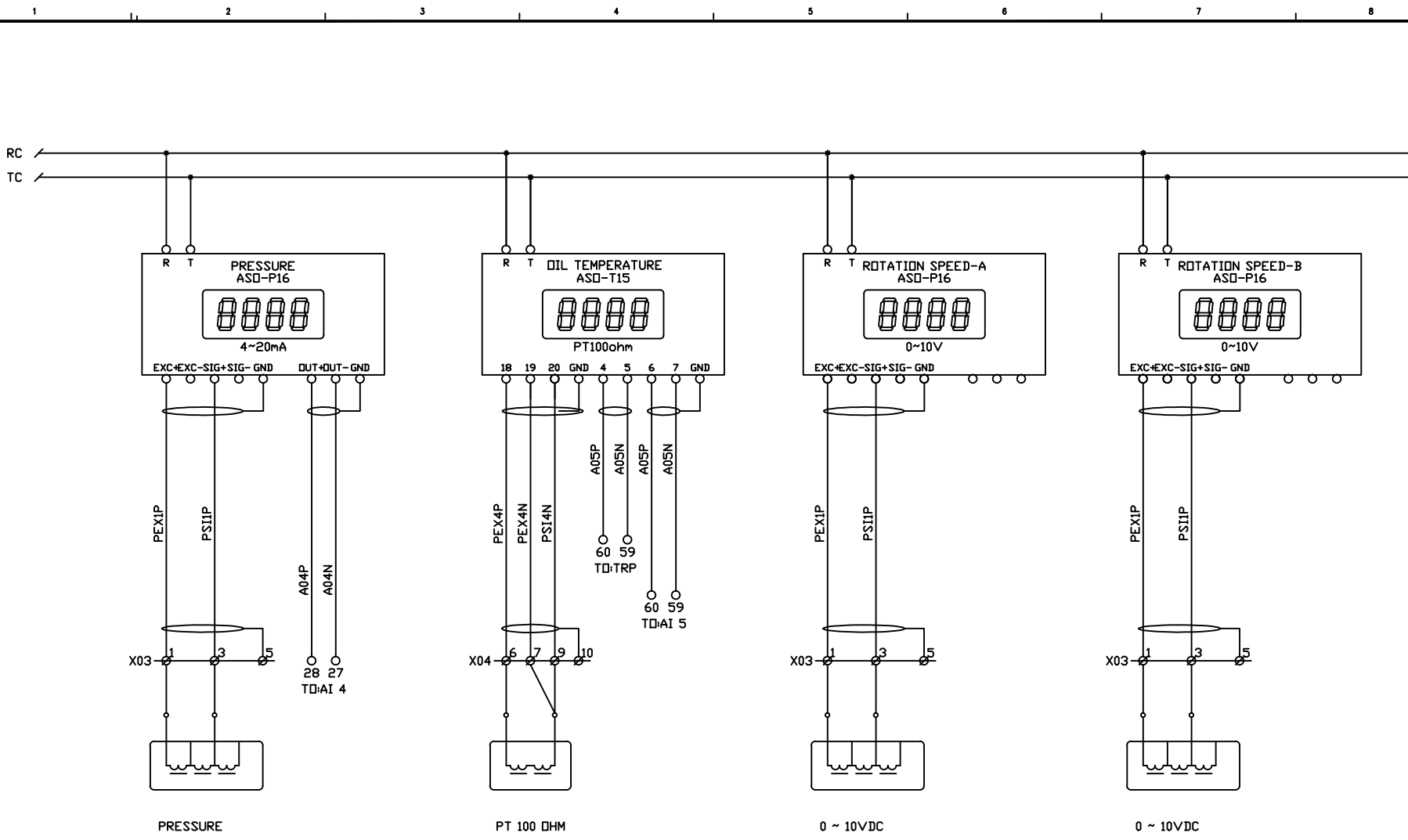

PRESSURE

PT 100 DHM

0 ~ 10VDC

0 ~ 10VDC

NO.	DATE	REVISIONS & DESCRIPTION	Drawn	Checked	Reviewed	Approved
13.10.15						

NO.	DESCRIPTION	MAY (KSI)	UNIT	TYPE	PLANT	TOTAL	REMARKS
	건설기계 부품연구원						
TITLE							PLANT
CENTER JOINT TESTER							NAME
ELECTRIC POWER PANEL							NO.
DATE							NO.
NO.							NO.

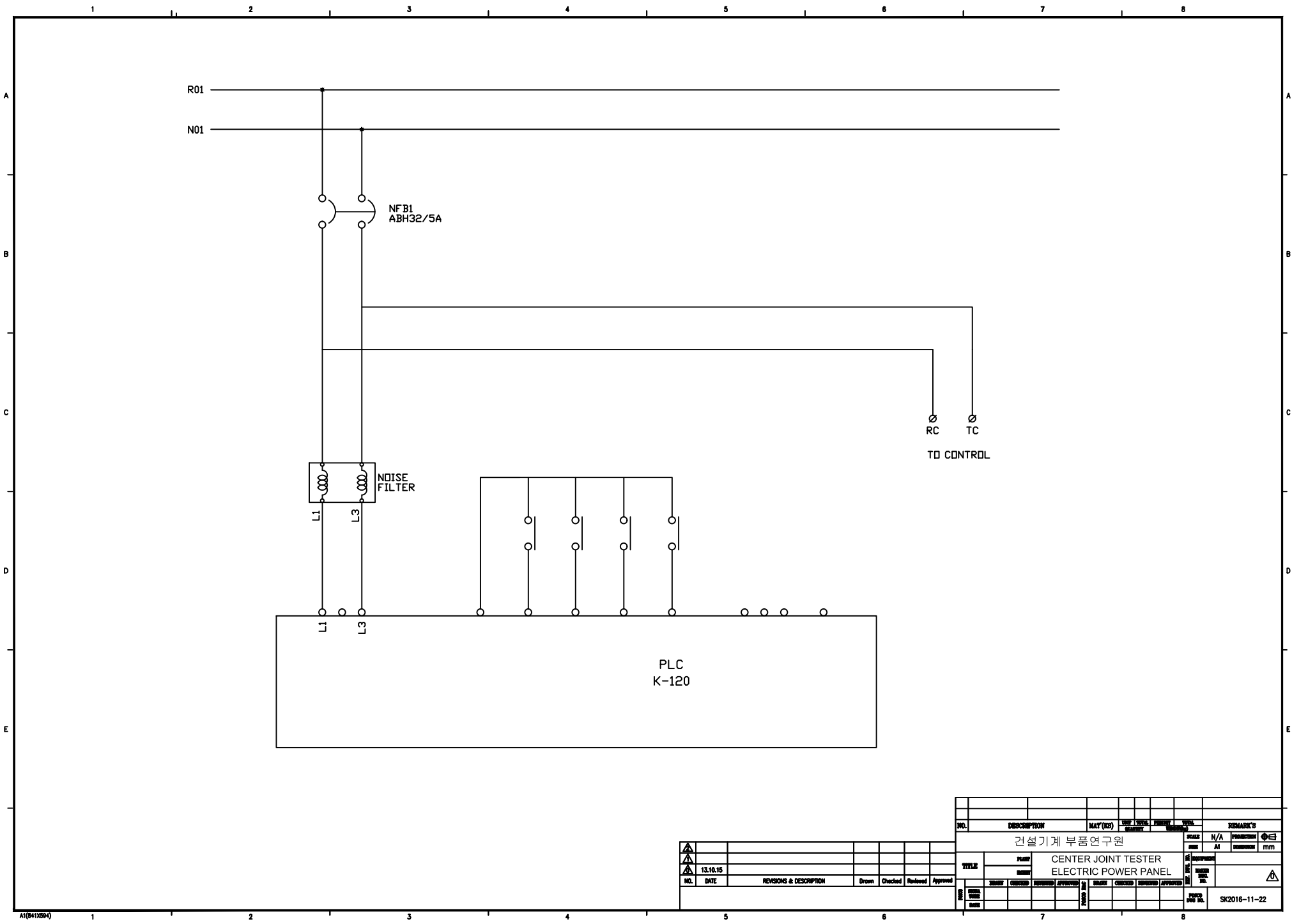

NO.	DATE	REVISIONS & DESCRIPTION	Drawn	Checked	Released	Approved
1	13.10.15					

NO.	DESCRIPTION	MAY (KWh)	UNIT	TYPE	PRICE	TOTAL	REMARKS
	건설기계 부품연구원						N/A
							At

TITLE	PLANT	DATE	SCALE	PROJECT NO.	REVISION NO.	PROJECT NO.
CENTER JOINT TESTER ELECTRIC POWER PANEL						

NO.	DATE	REVISIONS & DESCRIPTION	Drawn	Checked	Released	Approved

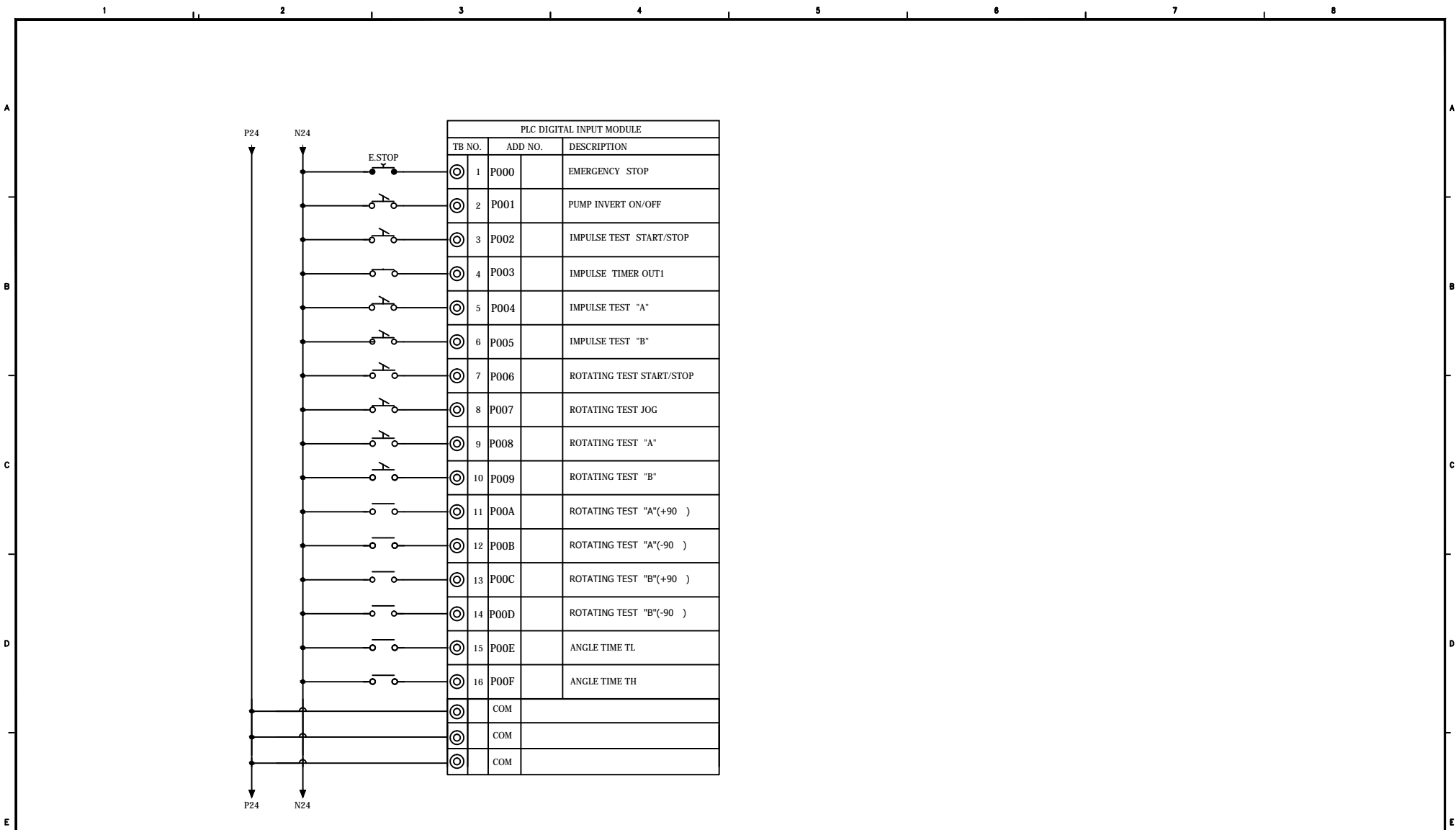

PLC DIGITAL INPUT MODULE		
TB NO.	ADD NO.	DESCRIPTION
1	P000	EMERGENCY STOP
2	P001	PUMP INVERT ON/OFF
3	P002	IMPULSE TEST START/STOP
4	P003	IMPULSE TIMER OUT1
5	P004	IMPULSE TEST "A"
6	P005	IMPULSE TEST "B"
7	P006	ROTATING TEST START/STOP
8	P007	ROTATING TEST JOG
9	P008	ROTATING TEST "A"
10	P009	ROTATING TEST "B"
11	P00A	ROTATING TEST "A"(+90 )
12	P00B	ROTATING TEST "A"(-90 )
13	P00C	ROTATING TEST "B"(+90 )
14	P00D	ROTATING TEST "B"(-90 )
15	P00E	ANGLE TIME TL
16	P00F	ANGLE TIME TH
	COM	
	COM	
	COM	

NO.	DATE	REVISIONS & DESCRIPTION	Drawn	Checked	Released	Approved
1	13.10.15					

NO.	DESCRIPTION	MAY (KWh)	UNIT	TYPE	PRICE	TOTAL	REMARKS
	건설기계 부품연구원						
<b>TITLE</b> CENTER JOINT TESTER ELECTRIC POWER PANEL							<b>SCALE</b> N/A <b>PROJECTION</b> 1st <b>DATE</b> 13.10.15 <b>NO.</b> SK2016-11-22

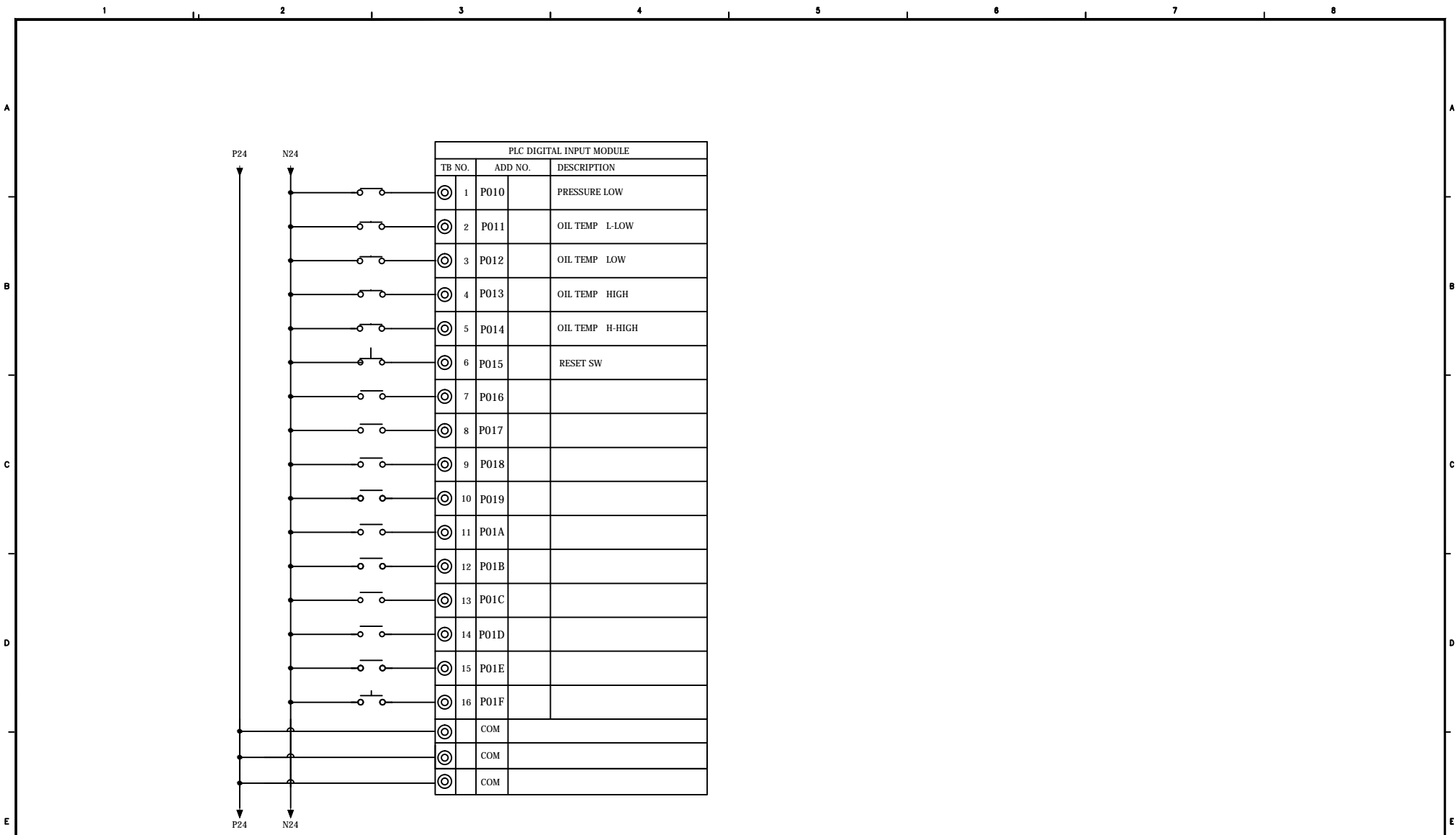

PLC DIGITAL INPUT MODULE		
TB NO.	ADD NO.	DESCRIPTION
1	P010	PRESSURE LOW
2	P011	OIL TEMP L-LOW
3	P012	OIL TEMP LOW
4	P013	OIL TEMP HIGH
5	P014	OIL TEMP H-HIGH
6	P015	RESET SW
7	P016	
8	P017	
9	P018	
10	P019	
11	P01A	
12	P01B	
13	P01C	
14	P01D	
15	P01E	
16	P01F	
	COM	
	COM	
	COM	

NO.		DESCRIPTION		DATE	TIME	PLANT	REVISION	REMARKS
		건설기계 부품연구원		13.10.15				
TITLE		CENTER JOINT TESTER ELECTRIC POWER PANEL		DRAWN	CHECKED	DESIGNED	APPROVED	
NO.		DATE		REVISIONS & DESCRIPTION	Drawn	Checked	Released	Approved
PROJECT NO.		SK2016-11-22						

PLC DIGITAL OUTPUT MODULE		
DESCRIPTION	ADD NO.	TB NO.
PUMP ON(INVERT)	P040	01
IMPULSE START	P041	02
IMPULSE COUNT UP	P042	03
IMPULSE TEST SOL	P043	04
ROTATING TEST JOG	P044	05
ROTATING TEST START	P045	06
ROTATING TEST "A"	P046	07
ROTATING TEST "B"	P047	08
SERVO E-STOP	P048	09
WATER SOL	P049	10
BUZZER	P04A	11
	P04B	12
	P04C	13
	P04D	14
	P04E	15
	P04F	16

	COM	
	COM	
	COM	
	COM	

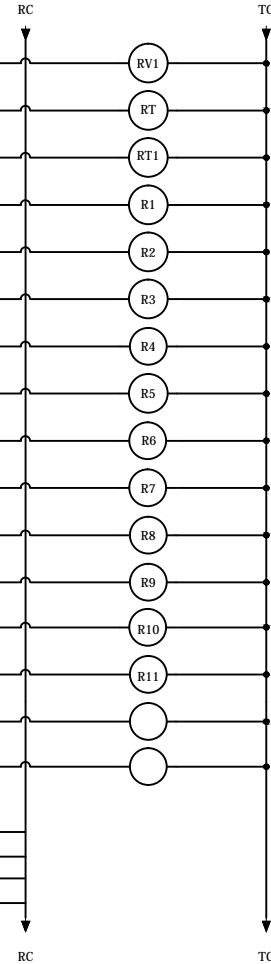

NO.	DATE	REVISIONS & DESCRIPTION	Drawn	Checked	Released	Approved
1	13.10.15					

NO.	DESCRIPTION	MAY (KSI)	UNIT	TYPE	QTY	REMARKS
	건설기계 부품연구원					
	CENTER JOINT TESTER					
	ELECTRIC POWER PANEL					